

---

## Installation Guide

---

The information enclosed in this installation guide is intended to provide a general outline to assist you during the process of installation. This guide does not cover every installation possibility, vehicle, or aspect of the installation process.

Retro Manufacturing, LLC, or its subsidiaries assume no responsibility for proper or improper installation. Every attempt has been made to make this installation guide as informative as possible. This guide may be updated from time to time, and specifications are subject to change without notice. Please check our website ([www.retromanufacturing.com](http://www.retromanufacturing.com)) for the latest updates.



# INSTALLATION

---

Thank you for purchasing RetroSound® Kick Panels. RetroSound® Kick Panels are expertly molded for a perfect fit. The speaker mounts are angled to direct sound upwards towards the listener for better stereo imaging.

## Precautions

It is best to consult a professional installation specialist to help with your installation.

## Important Installation Guidelines:

- Carefully read and understand the instructions before attempting installation.
- Always disconnect the negative (-) battery terminal before beginning any work. Failure to do so may result in damage to the unit, fire, injury, or death.
- Use high-quality connectors to prevent fire or damage to the unit.
- Carefully check the installation area before drilling to ensure you won't drill into the gas tank, fuel lines, brake lines, hydraulic lines, vacuum lines, or electrical wiring.
- Never run the speaker wires underneath the vehicle.
- Avoid running speaker wires over sharp edges and use rubber grommets to protect wires when routed through metal panels.

## Step #1 Remove Existing Kick Panels

---

Remove the existing kick panels by removing any screws or press clips holding the panels in place. It may be necessary to remove the rubber door seal first to remove the kick panels.

## Step #2 Route Speaker Wires

---

Route the speaker wires before installing your speakers. Always avoid sharp edges that could fray or cut the wiring and use rubber grommets to protect the speaker wires that need to be routed through metal. For the best quality connection and to minimize signal loss, always use high-quality connectors. Never run wires outside the vehicle.

## Step #3 (Optional) Cut Speaker Holes

---

If you are using larger speakers, you will need to enlarge the speaker opening in the kick panels. Use a speaker grill ring as a template to mark the size of the space required and the locations for the speaker's mounting screws. Use a razor knife or Dremel tool to carefully enlarge the opening and a 1/8-inch drill bit to drill the mounting holes.

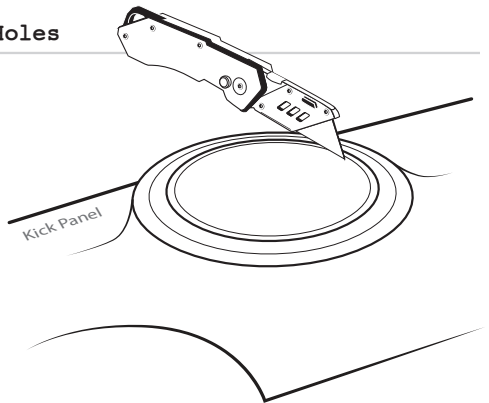

## Step #4 Mount Kick Panels

---

Mount the new kick panels using the fasteners from the factory kick panels. You may need to drill new mounting holes in the kick panels before mounting.

## Step #5 Connect the Speakers

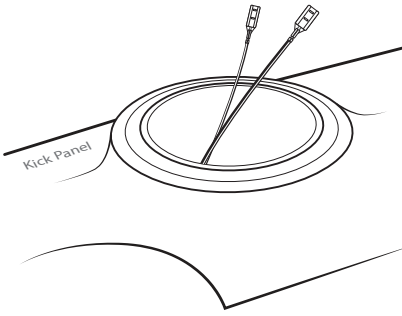

Feed the speaker wires through the speaker opening and connect to the speaker terminals.

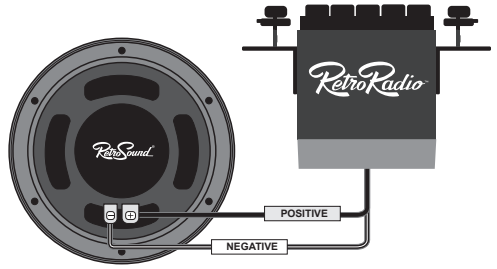

Connect the negative wire to the negative (-) speaker terminal and positive to the positive (+) speaker terminal.

### TIP: How to Remove Speaker Grills

To remove speaker grills either pull up on the grill's ring (Type A) or push down on the grill's ring (Type B).

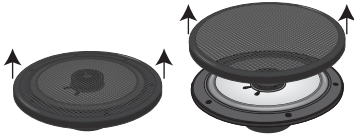

Type A: Pull up to remove

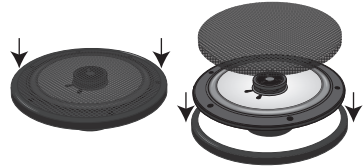

Type B: Push down to remove

## Step #6 Mount the Speakers

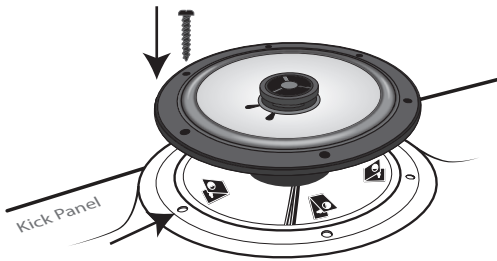

Fit the speaker into the cutout and secure it using the supplied screws. If needed, place a speed clip over each drilled hole before mounting the speaker. (Some models may require placing the grill base before placing the speaker.)

## Step #7 Complete the Installation

Tighten all screws until the speaker is snug and in place to prevent rattling. Be careful not to overtighten the screws. Complete the installation by placing the grill (if included) over the installed speaker.

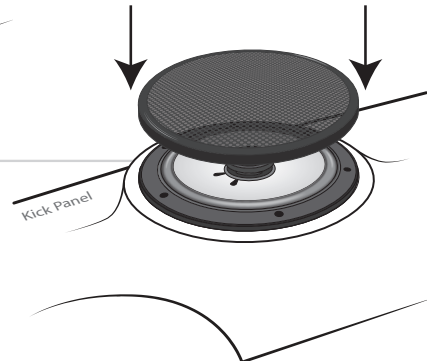

# Warranty

**IMPORTANT:** RetroSound® Kick Panels are designed to be modified to fit your particular mounting requirement. However, once modified, they are not covered by this warranty. Therefore, verify the speaker/vehicle fit before modification or installation.

Your kick panels come with a manufacturer's warranty covering any defects in materials and workmanship. Retro Manufacturing, LLC (collectively referred to as "the warranter"), at its option, will either (a) repair your unit with new or refurbished parts or (b) replace it with a new or refurbished unit. The warranty period starts from the original purchase date and is valid for the length of time indicated in the chart below. The decision to repair or replace will be made by the warranter.

ITEM	WARRANTY
Kick Panels	One (1) Year

During the "Parts" warranty period, there will be no charge for parts. You must mail in your unit during the warranty period at your expense. This warranty only applies to products purchased directly from Retro Manufacturing or an authorized dealer. This warranty is extended only to the original purchaser of a new product that was not sold "as is." A purchase receipt or other proof of the original purchase date is required for warranty service.

To handle a warranty issue, contact us at [tech@retromanufacturing.com](mailto:tech@retromanufacturing.com) or 888.325.1555 for a Return Authorization (RA) number. A RA number must accompany all returns and warranty issues. Any product received without a RA number will be refused.

## LIMITED WARRANTY-LIMITS AND EXCLUSIONS

This warranty ONLY COVERS failures due to defects in materials and workmanship and DOES NOT COVER normal wear and tear or cosmetic damage. The warranty ALSO DOES NOT COVER damages that occurred during shipment, failures which are caused by products not supplied by the warranter, failures that result from accident, misuse, abuse, neglect, bug infestation, mishandling, misapplication, alteration, faulty installation, set-up adjustment, maladjustment of consumer control, improper maintenance, improper antenna, inadequate signal reception or pickup, power line surge, improper voltage supply, lightning, modification, commercial use (such as use in hotels, offices, restaurants, or other business uses) or rental use of the product, or service by anyone other than Retro Manufacturing, LLC, or damage that is attributable to acts of God.

THERE ARE NO EXPRESS WARRANTIES EXCEPT AS LISTED UNDER LIMITED WARRANTY. THE WARRANTER IS NOT LIABLE FOR INCIDENTAL OR CONSEQUENTIAL DAMAGES RESULTING FROM THE USE OF THIS UNIT OR ARISING OUT OF ANY BREACH OF THIS WARRANTY. (As examples, this excludes damages for lost time, the cost of having someone remove or re-install an installed unit if applicable, travel to and from the servicer, and loss of media, data, or other memory contents. The items listed are not exclusive but are for illustration only.) ALL EXPRESS AND IMPLIED WARRANTIES, INCLUDING THE WARRANTY OF MERCHANTABILITY, ARE LIMITED TO THE PERIOD OF THE LIMITED WARRANTY.

Some states do not allow the exclusion or limitation of incidental or consequential damages or limitations on how long an implied warranty lasts, so the exclusions may not apply to you. This warranty gives you specific legal rights, and you may also have other rights which vary from state to state. If a problem with this unit develops during or after the warranty period, you may contact your dealer or Retro Manufacturing, LLC.



7470 Commercial Way, Henderson, NV 89011

Phone: 888.325.1555 • Fax: 702.483.2229

©2020 Retro Manufacturing, LLC | Published: 08/18/21